

DH-IPC-PFW8802-A180

4x2MP Multi-Sensor Panoramic IR Bullet Network Camera



- Four 1/1.9" 2Megapixel progressive scan CMOS
- H.265/H.264 triple-stream encoding
- Max 25fps@4096x1800
- Support 180-degree panoramic view
- Day/Night(ICR), 3DNR, AWB, AGC, BLC, WDR
- Smart detection
- Intelligent Function
- Max. IR LEDs length 30m
- Micro SD memory, IP67, IK10,PoE+



System Overview

The multi-sensor camera provides added flexibility for capturing wide area video surveillance. With four 2MP sensors working in tandem to create a comprehensive 180-degree overview, the camera can replace multiple single-sensor cameras providing a higher return on investment. With the field of view being divided across the four sensors, adjustments can be made to each sensor for contrast and brightness, resulting in a crystal-clear panorama.

Functions

True Day/Night

A day/night mechanical IR cut filter makes this camera ideal for applications with fluctuating lighting conditions, delivering color images during the day and automatically switching to monochrome as the scene darkens.

Starlight Technology

Featured with Dahua Starlight Technology, the camera is ideal for applications with challenging light conditions. Its low light performance delivers usable video with minimal ambient light. Even in extreme low light conditions, Starlight Technology is capable of delivering color images in nearly complete darkness.

Intelligent Video System (IVS)

Dahua camera is equipped with a built-in intelligent analytic algorithm based on video, which can realize intelligent functions like Tripwire, Intrusion, Abandoned, Missing and so on, to quickly and accurately respond to monitoring events in specific area. It can enhance monitoring efficiency. In addition, the camera supports intelligent tamper detection, which is to generate warning message via detecting dramatic scene change and to guarantee effective video surveillance.

Smart IR

With IR illumination, detailed images can be captured in low light or total darkness. The camera's Smart IR technology adjusts the intensity of camera's infrared LEDs to compensate the distance of an object. Smart

IR technology prevents IR LEDs from whitening out images as they come closer to the camera. The camera's integrated infrared illumination provides high performance in extreme low-light environments up to 30m (98ft).

Smart Codec (H.265+ & H.264+)

Smart Codec is the optimized implementation of standard video compression (H.265 & H.264) that uses a scene-adaptive encoding strategy, dynamic GOP, dynamic ROI, flexible multi-frame reference structure and intelligent noise reduction to deliver high-quality video without straining the network. Smart Codec technology reduces bit rate and storage requirements by up to 70% when compared to the standard video compression.

Protection (IP67, IK10, wide voltage)

Supporting $\pm 25\%$ input voltage tolerance, this camera suits even the most unstable conditions for outdoor applications. Its 6KV lightning rating provides effective protection for both the camera and its structure against lightning. Subjected and certified to rigorous dust and immersion tests (IP67) and impact tests (IK10), The camera complies with an IK10 impact rating making it capable of withstanding the equivalent of 5 kg (11.02 lbs) of force dropped from a height of 40 cm (15.75 in.)

Environmental

Standard Dahua camera can function from -30°C to $+60^{\circ}\text{C}$ (-22°F to $+140^{\circ}\text{F}$) with 95% humidity, meanwhile some models support heater module optional which allows the camera to function from -40°C to $+60^{\circ}\text{C}$ (-40°F to $+140^{\circ}\text{F}$). With a temperature range of -40°C to $+60^{\circ}\text{C}$, the camera is designed for extreme temperature environments.

Technical Specification

Camera

Image Sensor	Four 1/1.9" 2Megapixel progressive scan CMOS
Effective Pixels	4096(H)x1800(V)
RAM/ROM	1024MB/128MB
Scanning System	Progressive
Electronic Shutter Speed	Auto/Manual, 1/3~1/100000s
Minimum Illumination	0.005Lux/F2.2(Color,1/3s,30IRE) 0.03Lux/F2.2(Color,1/30s,30IRE) 0Lux/F2.2(IR on)
S/N Ratio	More than 50dB
IR Distance	Distance up to 30m(98ft)
IR On/Off Control	Auto/ Manual
IR LEDs	8

Lens

Lens Type	Fixed			
Mount Type	Board-in			
Focal Length	5.0mm			
Max. Aperture	F2.2			
Angle of View	H: 180°, V:80°			
Optical Zoom	N/A			
Focus Control	Fixed			
Close Focus Distance	N/A			
DORI Distance	Detect	Observe	Recognize	Identify
	53m(178ft)	21m(69ft)	10m(33ft)	5m(17ft)

Pan/Tilt/Rotation

Pan/Tilt/Rotation Range	Pan:0°~360°; Tilt:0°~90°; Rotation:0°~360°
-------------------------	--

Intelligence

Event Trigger	Motion detection, Video tampering , Scene changing, Network disconnection , IP address conflict, Illegal Access,Storage anomaly
IVS	Tripwire, Intrusion, Object Abandoned/Missing
Advanced Intelligent Functions	Heat Map, E-PTZ

Video

Compression	H.265/H.264/H.264B/H.264H/MJPEG(Sub Stream)
Smart Codec	Support H.265+/H.264+
Streaming Capability	3 Streams
Resolution	4096x1800/3840x1680/2880x1264/ /1920x832/1280x560/1024X452
Frame Rate	Main Stream: 4096x1800 (1~25fps)
	Sub Stream: 1024X452 (1 ~ 25fps)
	Third Stream: 1920x832 (1 ~ 25fps)

Bit Rate Control	CBR/VBR
Bit Rate	H.265: 9Kbps~ 9472Kbps H.264: 24Kbps~ 15616Kbps
Day/Night	Auto(ICR) / Color / B/W
BLC Mode	BLC / HLC / WDR(120dB)
White Balance	Auto/Natural/Street Lamp/Outdoor/Manual
Gain Control	Auto/Manual
Noise Reduction	3D DNR
Motion Detetion	Off / On (4 Zone, Rectangle)
Region of Interest	Off / On (4 Zone)
Electronic Image Stabilization(EIS)	N/A
Smart IR	Support
Defog	N/A
Digital Zoom	16x
Flip	N/A
Mirror	N/A
Privacy Masking	Off / On (4 Area, Rectangle)

Audio

Compression	G.711a/G.711Mu/AAC/ G.726
-------------	---------------------------

Network

Ethernet	RJ-45 (100/1000Base-T)
Protocol	HTTP;HTTps;TCP;ARP;RTSP;RTP;UDP;RTCP;SMTP; FTP;DHCP;DNS;DDNS;PPPOE;IPv4/v6;QoS;UPnP; NTP;Bonjour;IEEE 802.1x;Multicast;ICMP;IGMP;S NMP;TLS
Interoperability	ONVIF Profile S&G, API
Streaming Method	Unicast / Multicast
Max. User Access	10 Users/20 Users
Edge Storage	NAS Local PC for instant recording Mirco SD card 128GB
Web Viewer	IE, Chrome, Firefox, Safari
Management Software	Smart PSS, DSS, DMSS
Smart Phone	IOS, Android

Certifications

Certifications	CE (EN 60950:2000) UL:UL60950-1 FCC: FCC Part 15 Subpart B
----------------	--

Interface

Video Interface	1 Port(For adjustment only)
Audio Interface	1/1 channel In/Out
RS485	N/A
Alarm	2 channel In: 5mA 5VDC 2 channel Out: 1A 30VDC / 0.5A 50VAC

Electrical

Power Supply	AC24V, PoE+(802.3at)(Class 4)
Power Consumption	<25.5W

Environmental

Operating Conditions	-40° C ~ +60° C (-40° F ~ +140° F) / Less than 95% RH
Storage Conditions	-40° C ~ +60° C (-40° F ~ +140° F) / Less than 95% RH
Ingress Protection	IP67
Vandal Resistance	IK10

Construction

Casing	Metal
Dimensions	298.3mm×172.5mm×120.5mm (11.74"×6.79"×4.74")
Net Weight	2.7kg(5.95lb)
Gross Weight	3.61kg(7.96lb)

Ordering Information

Type	Part Number	Description
4x2MP camera	DH-IPC-PFW8802P-A180	4x2MP Multi-Sensor Panoramic IR Bullet Network Camera, PAL
	DH-IPC-PFW8802N-A180	4x2MP Multi-Sensor Panoramic IR Bullet Network Camera,NTSC
	IPC-PFW8802P-A180	4x2MP Multi-Sensor Panoramic IR Bullet Network Camera, PAL
	IPC-PFW8802N-A180	4x2MP Multi-Sensor Panoramic IR Bullet Network Camera,NTSC
Accessories (optional)	PFA120	Junction Box
	PFA150	Pole mount
	PFA151	Corner mount

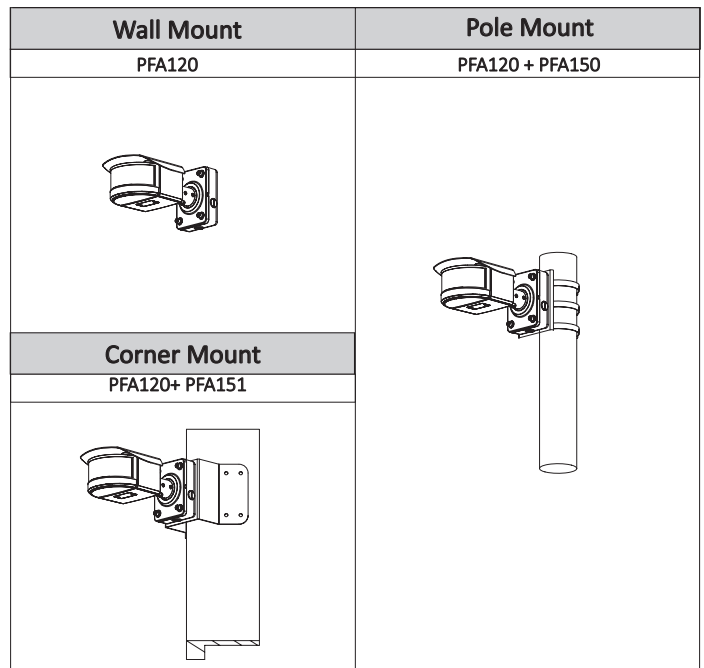

Dimensions (mm/inch)

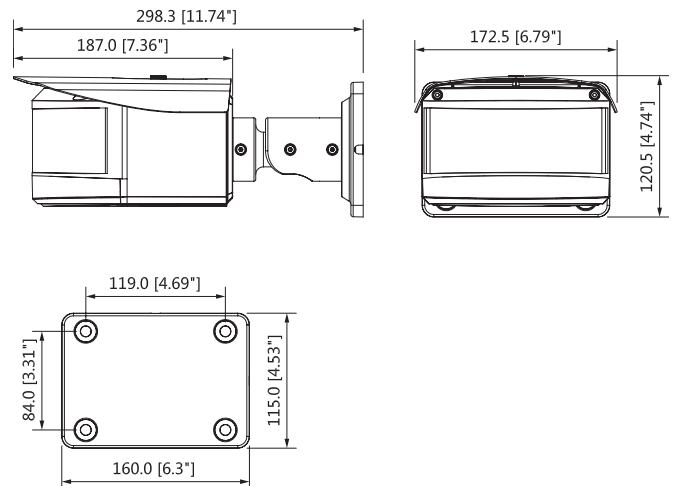

Accessories

Optional:



PFA120
Junction Box



PFA150
Pole mount

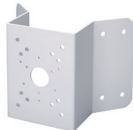

PFA151
Corner mount